



Tutorial

IRS, LIS, and Radio Stripes-Aided Wireless Communications: A Tutorial

Ali Gashtasbi ^{1,*}, Mário Marques da Silva ^{2,3,4}  and Rui Dinis ^{1,3,4} ¹ Faculty of Sciences and Technology, Universidade Nova, 2829-516 Caparica, Portugal² Department of Sciences and Technologies, Universidade Autónoma de Lisboa, 1169-023 Lisboa, Portugal³ Autonoma TechLab, 1169-023 Lisboa, Portugal⁴ Instituto de Telecomunicações, 1049-001 Lisboa, Portugal

* Correspondence: a.gashtasbi@campus.fct.unl.pt

Abstract: This is a tutorial on current techniques that use a huge number of antennas in intelligent reflecting surfaces (IRS), large intelligent surfaces (LIS), and radio stripes (RS), highlighting the similarities, differences, advantages, and drawbacks. A comparison between IRS, LIS, and RS is performed in terms of the implementation and capabilities, in the form of a tutorial. We begin by introducing the IRS, LIS, and RS as promising technologies for 6 G wireless technology. Then, we will look at how the three notions are applied in wireless networks. We discuss various performance indicators and methodologies for characterizing and improving the performance of IRS, LIS, and RS-assisted wireless networks. We cover rate maximization, power consumption reduction, and cost implementation concerns in order to take advantage of the performance increase. Furthermore, we extend the discussion to some cases of emerging use. In the description of the three concepts, IRS-assisted communication was introduced as a passive system, considering the capacity/data rate, with power optimization being an advantage, while channel estimation was a challenge. LIS is an active component that goes beyond massive MIMO; a recent study found that channel estimation issues in IRS had improved. In comparison to IRS, capacity enhancement is a highlight, and user interference showed a trend of decreasing. However, power consumption due to utilizing power amplifiers has restrictions. The third technique for increasing coverage is cell-free massive MIMO with RS, with easy deployment in communication network structures. It is demonstrated to have suitable energy efficiency and power consumption. Finally, for future work, we further propose expanding the conversation to include some cases of new uses, such as complexity reduction; design and simulation with LDPC code could be a solution to decreasing complexity.

Keywords: IRS; LIS; RS; 6 G

Citation: Gashtasbi, A.; da Silva, M.M.; Dinis, R. IRS, LIS, and Radio Stripes-Aided Wireless Communications: A Tutorial. *Appl. Sci.* **2022**, *12*, 12696. <https://doi.org/10.3390/app122412696>

Academic Editor: Juan-Carlos Cano

Received: 14 November 2022

Accepted: 7 December 2022

Published: 11 December 2022

Publisher's Note: MDPI stays neutral with regard to jurisdictional claims in published maps and institutional affiliations.



Copyright: © 2022 by the authors. Licensee MDPI, Basel, Switzerland. This article is an open access article distributed under the terms and conditions of the Creative Commons Attribution (CC BY) license (<https://creativecommons.org/licenses/by/4.0/>).

1. Introduction

1.1. Motivation

The fifth generation (5 G) telecommunications network structure has been developed and deployed. With the increasing popularity of Internet of Things (IoT) adoption among users, it is urgent to upgrade the existing working network to 6 G [1]. While improving the new design, attention to the needs of the users is expected. It includes increased capacity, higher data rates, increased bandwidth, less interference, the highest quality of service (QoS) for users, and low-cost implementation for operators [2]. This optimization is created on the side of the base station by increasing the number of antennas using MIMO, cell-free MIMO technology, and also using low-power small cells in a dense network. Therefore, designers are looking for three new techniques—IRS, LIS, and radio stripes—to deploy in the network. Intelligent reflecting surfaces (IRS) have piqued the interest of academics and businesses as a possible early-stage technology [3]. Usually, a wireless cellular communications network uses transceiver end-point transmission techniques to limit or use

the flexible multipath publication environment for better quality, but it has not been able to manage the environment itself. An IRS might be used to construct a programmable and controllable intelligent radio environment. The metasurface structure is vast and very thin, made of dielectric or metal. These metasurfaces, which have a unique physical structure, contain several passive sub-wavelength dispersion components. Software may regulate the component to alter the electromagnetic (EM) parameters of the reflected radio frequency (RF) signals, such as phase shift [1]. A unified phase control of all the scattering components allows for flexible real-time modification of the reflected radiation pattern of incoming RF signals, providing new degrees of freedom for improving the overall wireless network performance [4].

In contrast, the large intelligent surface (LIS) was used to describe enormous active antenna arrays that were similar to the massive MIMO (mMIMO) concept, but much larger [5]. As a result, a LIS creates, transmits, and receives signals. The arrays are not only large but also comprise very small pieces [6]. This allows them to manipulate electromagnetic waves on the surface nearly indefinitely. The LIS concept can be seen as a larger version of traditional, huge MIMO systems. Intelligent surfaces are physical surfaces that are, in theory, electromagnetically enabled surfaces, meaning that each part of the surface may broadcast and receive electromagnetic waves. Being able to control these fields with great accuracy makes it possible to concentrate energy in three-dimensional space so that it can be sent and received [7]. Therefore, the surfaces will introduce whole new possibilities for communications, as well as sensing and controlling the electromagnetic environment. Intelligent surfaces are the inevitable evolution of the mMIMO concept taken to its logical conclusion. Massive MIMO has been proven to offer several benefits, but only limited efforts have been made to prevent harmful effects from a base station, with multiple antennas that use surfaces throughout the physical area as antennas [8].

Another new and attractive concept for new research is radio stripes (RS). In traditional cell-free (CF) mMIMO systems, access points (APs) are distributed geographically and collaborate in transmitting and receiving by sharing critical data, including such channel state information (CSI) or other data, over a separate fronthaul link to the central processing unit (CPU). As a result, the fundamental barrier for the practical implementation of a cell-free (CF) mMIMO network is the significant fronthaul capacity and signaling demands between the APs and the CPU, as well as the high network implementation cost due to the extremely dense long-distance cable required to interconnect all components. The RS concept is one promising way to establish a CF mMIMO network. It is made up of a stripe coupled to a CPU and numerous antennae that collaborate phase-coherently. An AP is represented by a group of antenna elements that are linked to the local processing unit. As these APs are all connected to the same cable, they can share synchronization, data transfer, and power link. This means that each AP and the CPU that goes with it do not need a separate fronthaul link [9].

Previous works considered all IRS, LIS, and RS separately, and most studies evaluated LIS and IRS passively in the same way. In this new work, a comparison of the implementation and capabilities for the three-technique approach is carried out.

1.2. Massive MIMO, Ultra Massive MIMO, and Cell-Free Massive MIMO

MIMO is a technique of spatial multiplexing that makes use of several antennas at both the transmitter and the receiver. Because the receiver side sees several versions of the identical signal that has been sent, it can extract information more effectively, preventing the amount of fading that occurs on a smaller scale and consequently improving communication dependability. The number of wireless devices in use along with the amount of data utilized on each device is rapidly increasing, resulting in an exponential increase in data traffic demand. Unfortunately, present MIMO systems are incapable of meeting such needs due to the restrictions of only a few antennas at base stations (BS) [10]. Due to interference, the capacity to serve multiple consumers at a given time-frequency resource is limited, restricting the multiplexing gain. Massive MIMO, a new type of multi-user

MIMO, has recently become a promising way to improve wireless communication in the future [11,12].

Massive MIMO BS have so many antennas that fading on a small scale, interference, and noise have almost no effect due to the array gain. A mMIMO BS can provide service to tens of users at once for a given time-frequency resource, resulting in huge multiplexing benefits and significant improvements in terms of spectral efficiency (SE), measured in bits/s/Hz, and energy efficiency (EE), measured in bits/J [10,13]. Massive MIMO systems deliver faster data rates without requiring additional bandwidth or the installation of extra BS. The primary advantages of huge MIMO systems are better scalability, less power used to send signals, better use of the spectrum, and easier signal processing [14]. The signal-to-noise ratio varies dramatically between cell-center and cell-edge UEs, which is a major issue for mMIMO. These issues restrict the deployment of mMIMO beyond 5 G (B5G) networks, which is addressed by the cell-free mMIMO network. The term “CF mMIMO systems” refers to a better way to use decentralized mMIMO systems in the real communication world [15]. In CF mMIMO systems, all APs are linked to a CPU. The CPU manages each AP as a mMIMO network with no cell borders so that every user can receive and send data at the same time. By using spatial multiplexing techniques, the CPU makes it possible for all APs to serve every user using a similar time-frequency range of resources. Cell-free massive MIMO makes use of the advantageous propagation and channel hardening properties when the number of APs is sufficient to multiplex a lot of users on the same time-frequency resource with low inter-user interference [16]. As a result, it may provide high spectral efficiency with minimal signal processing. Additionally, a cell-free massive MIMO system places the service antennas near the users, resulting in a high level of macro-diversity and reduced path losses. As a result, numerous users can be serviced at the same time with consistently high-quality service. Furthermore, cell-free massive MIMO outperforms standard tiny-cell technology, in which every user is serviced through a single AP. Cell-free massive MIMO is a promising approach for next-generation wireless communication technologies [16].

Transmission distance in the THz band shows a restriction due to power limitations and high propagation losses. Ultra-massive MIMO (UM-MIMO) communications, which might incorporate a huge number of nano-antennas in small dimensions to boost communication area and data rates at THz frequencies, are suggested as a solution. Consequently, system capacity is increased. In comparison to massive MIMO communication systems, the number of antennas and the dimension of the antenna array are enhanced in ultra-massive MIMO communication systems, resulting in unique channel characteristics [17,18].

1.3. Organization of This Paper

The remainder of the essay is arranged as follows. Section 2 provides an overview of the IRS and subjects attended in different articles. The LIS is introduced after the IRS, with an active element with related issues to the LIS, and then analyzes the radio stripes as a novel subject. In Section 3, we introduce four different receivers: the zero forcing (ZF), minimum mean square error (MMSE), maximum ratio combiner (MRC), and equal gain combiner (EGC) for LIS and radio stripes. Section 4 summarizes the article. Finally, Section 5 suggests future research.

2. Several Promising Techniques: IRS, LIS, and Radio Stripes

We consider the following three newly proposed concepts: IRS, LIS, and RS.

2.1. Categorizing Recent Studies on Intelligent Reflecting Surfaces

An IRS structure defines a two-dimensional electromagnetic surface as one that is made up of many passive meta-material segments that can be set up in different ways to change the phase of incoming signals and reflect them. This phase shift is controlled by the BS using external signals delivered over a backhaul control link [2]. As a result, the re-

ceiving BS signal can be changed while still displaying the obtained signal to the users [19]. Consequently, using IRS improves the signal energy strength received by faraway users and widens the BS coverage. In this context, the IRS and BS must collaborate to create the beamformer parameters. This results in the desired channel conditions, in which the BS communicates information to numerous users via the IRS. The IRS is separate from other comparable wireless network technologies, including relaying and backscatter telecommunications. Additionally, near-field beamforming has been investigated in [4] to significantly enhance the efficiency of wireless technology. In this technique, the phase shifts of the LIS components are intelligently modified to receive a coherent combination of the reflected signals at the appropriate receiver (Figure 1) [20]. The IRS is distinguished by the other following characteristics:

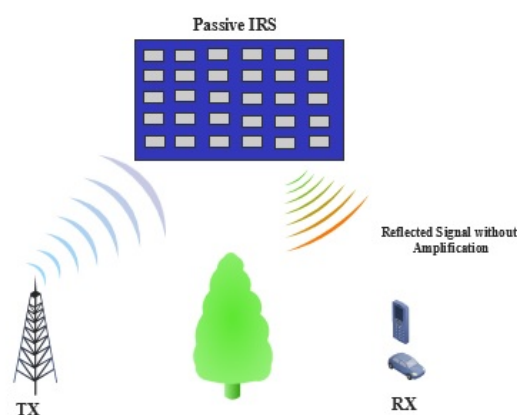

Figure 1. Block diagram of an IRS-enhanced wireless system.

2.1.1. Capacity and Data Rate Evaluations of IRS-Aided Communications

An IRS is a promising approach for increasing wireless network communication capacity while remaining economical and energy efficient by suitably modifying signal propagation through the tuning of many passive reflecting components [21]. The purpose of the publication [5] is to define the essential capacity restriction of IRS-assisted point-to-point MIMO communication networks with multi-antenna transmitters and receivers in general, by finding the optimal IRS reflection to maximize capacity [22].

2.1.2. Power/Spectral Optimizations in IRS-Aided Communications

Energy efficiency, measured by the ratio of spectral efficiency to power consumption, has become a key performance indicator for making wireless networks that are good for the environment and last a long time [20]. Reconfigurable intelligent surface (RIS)-assisted wireless communication has recently been presented as a promising approach to improving the energy efficiency of wireless networks. A RIS is a low-cost passive metasurface that can be used to turn a wireless channel into a region with some predictability [23]. In order to enhance user communication quality and optimize the characteristics of wave propagation, a BS transmits control signals to a RIS controller in the RIS communication structure. The RIS only serves as a reflector and accomplishes no digitization. Therefore, when used correctly, a RIS uses significantly minimal energy than standard amplify-and-forward (AF) relays [15,24].

2.1.3. Channel Estimation for IRS-Aided Communications

Despite the benefits of an IRS, it has gained a lot of attention in the cellular communication industry. Channel estimation (CE) is not easy, despite the IRS's passive nature and extensive sources for reflecting arrays. Even though it is hard to obtain, CSI is one of the most important things in data transmission [25]. As IRS is passive, traditional CE methods cannot be used to estimate the reflected channels of wireless communication systems that use IRS. To progressively resolve the CSI at the RIS, a new channel estimation approach

is provided, and the passive beamforming at the RIS is adjusted to improve the channel gains [26].

The representative findings of recent studies on an IRS are shown in Table 1.

Table 1. Representative Overview of Recent Studies on an IRS.

Reference	Main Contribution
[5]	Monte Carlo simulations demonstrated that capacity degradation due to phase errors is inversely proportional to SNR, which is more apparent for large L values.
[15]	An energy-efficient design is created to maximize the system's energy efficiency while considering both transmit power and IRS phase shift limits.
[19]	Because of the uncertainties imposed by environment dynamics and the quick changes in the IRS setup, channel estimate is a vital task of IRS. This research provides a FL framework for simultaneously estimating direct and cascaded channels in IRS-assisted wireless systems.
[21]	This paper aims to characterize the fundamental capacity limit of IRS-aided point-to-point MIMO communication systems with multi-antenna transmitters and receivers. They examined how best to optimize the IRS reflection coefficients and the MIMO transmit covariance matrix.
[22]	This article evaluates the IRS's capacity limits. It investigates ways to jointly optimize the IRS reflection matrix and wireless resource allocation while limiting the number of IRS reconfiguration times.
[23]	The energy efficiency of the network is maximized in this research by dynamically regulating the on-off status of each RIS and maximizing the reflection coefficients matrix of the RIS.
[24]	This paper presented techniques to minimize the UAV energy consumption by IRS.
[25]	Channel estimation (CE) is somewhat challenging. To solve this problem, this paper designs a CE scheme for large IRS-assisted multi-user wireless communication systems.

2.2. Categorizing Recent Studies on Large Intelligent Surfaces

A LIS is a revolutionary technique in the fields of wireless communications, signal positioning, and remote signal control. It is made up of a continuous radiating surface that is close to the users and can send and receive information (this is what base stations used to do). A LIS functions as a radio access point, allowing users to communicate directly with it. A LIS, unlike traditional IRS, functions as an adjustable reflector between the base station and the users, occupying a section of the channel. A LIS includes full receivers and baseband processing capability to acquire CSI from pilots sent by users (Figure 2). This makes it possible to accurately calculate the relevant equalization matrix and then find it in the LIS [27].

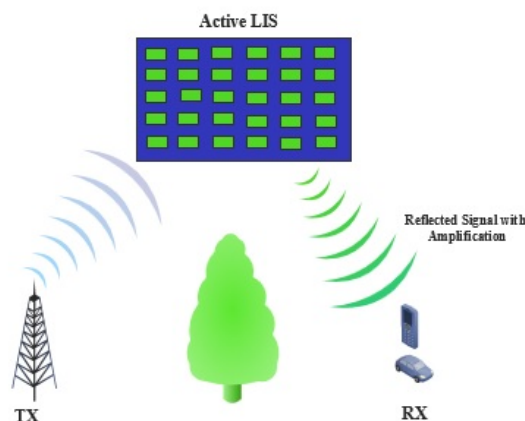

Figure 2. Block diagram of a LIS serving multiple users simultaneously.

2.2.1. Power Consumption LIS-Aided Communications

Because users and the LIS are close to each other, there is less route loss, and the antenna gain is high, so it is expected that the transmit power on both sides of the communication will be low. This makes it possible for inexpensive and energy-efficient analog elements to be widely used.

In comparison to massive MIMO, users are in the near field region, which is adjacent to the LIS in reference to its size. Being located in the near field necessitates using spherical waveform channel models instead of the planar wave approximation, which is often used in massive MIMO and further cellular systems [28].

The LIS is composed of a variety of tiny panels, each of which produces multiple baseband outputs and may be set on and off. Terminals in panel-based LIS must be allocated to panels in such a way that all terminals obtain an acceptable quality of service (QoS). In order to achieve the highest possible signal-to-interference plus noise ratio (SINR) across all terminals, scientists want to choose a certain number of panels to activate and allocate them to a predetermined number of terminals. Therefore, it is advantageous to turn off the components with poor channels to conserve energy (there is a hardware-induced power cost for having antennas on). We must make sure that the baseband outputs at the back are connected to the activated parts of the LIS because a significant portion of the LIS is currently deactivated [7].

2.2.2. LIS-Aided Communications with Decreased User Interference

A LIS system is made up of several tiny LIS units, with various benefits over a centralized implementation. To begin with, it is possible to maintain the area of each LIS surface unit at a tiny level that enables variable implementations and configurations [28]. Second, LIS units can be inserted, removed, or changed without dramatically altering the system design. In contrast, with a relatively tiny surface area, those electromagnetic waves do not overlap each other. Therefore, each LIS unit is capable of preventing inter-user interference [16].

The development of strategies has been looked at in terms of massive MIMO, LIS, and RS-based systems, with a focus on making interference-suppressing uplink detection algorithms based on ZF, MRC, EGC, and MMSE [29].

2.2.3. Complexity Analysis of LIS-Aided Communications

Despite its potential use, the implementation and computational complexity are big challenges in the LIS structure [7]. Moreover, LIS deployment is complex and raises a variety of new research issues [30]. One potential issue is hardware impairments (HWI), which include transmitting errors in analog systems, quantization issues, RF deficiencies, power amplifier nonlinearity, and time and frequency synchronization faults, among other issues. These HWI are common in modern communications systems, but they are more severe in LIS because of the larger contact area (for example, when using LIS in front of long buildings or walls). As a result, in real-world implementations, the HWI may limit the capabilities of LIS [27].

2.2.4. Capacity/Data Rate Analyses of LIS-Aided Communications

Massive MIMO systems have developed into cutting-edge LIS technology, providing for huge gains in capacity enhancements. The large antenna arrays offer significant advantages [31]. To keep the methodology and deployment simple, it is best to design and set up the LIS with panels that are either enabled or disabled and are linked to terminals based on how well they propagate [6,32]. It is noticeable that complex optimization difficulties might arise as a result of the corresponding spatial allocation of resources to maximize terminals as well as overall bit rates [16].

The distribution of power received from users is not uniform over the surface; the same user's signal is received with varying signal intensities from different regions of the LIS. We can take advantage of this by employing localized digital signal processing, re-

sulting in the more effective use of computational resources and connectivity bandwidth without severely compromising system performance [33].

When the number of terminals increases, the LIS performs very well and is very good at reducing interference. This makes it a strong candidate for data transmission in communication systems that go beyond mMIMO and increase capacity [31].

Other LIS research has focused on the LIS principal concept [34,35], system performance [25], communication modeling and fundamentals of the LIS [31,36], aspects of deployment by recognizing and addressing implementation issues, as well as effective LIS implementation [8,33].

Table 2 lists the main contributions of recent research on the LIS.

Table 2. Representative Overview of Recent Research on the LIS.

Reference	Main Contribution
[6]	One of the disadvantages of the implementation of the LIS is the complexity of the panels. This paper offers a method for omitting the complexity involved in managing the set of activated panels.
[7]	It is demonstrated that when terminal density grows, it is preferable to use smaller panels and, as a result, more outputs per m ² .
[8]	This research investigates the capabilities of single-antenna terminals being connected with huge antenna arrays installed on surfaces. That is, the entire surface is used as an IRS array. If the surface area is high enough, the received signal after matched filtering (MF) can be well represented by the intersymbol interference (ISI) channel.
[16]	The best user assignments can be efficiently obtained using classical linear assignment problems (LAPs) developed based on the pleasant property of effective inter-user interference suppression of the LIS units.
[27]	The capacity and utility of the surface area are both reduced with HWI due to the greater effective noise level induced by the HWI. A distributed LIS system can be implemented by dividing it into numerous small LIS units, where the effects of the HWI can be considerably reduced due to the smaller surface area of each unit.
[30]	As the number of antennas increases, hardware impairments, noise, and interference from channel estimate errors and the non-line-of-sight become insignificant. This paper investigated the uplink rate in the presence of restrictions such as device-specific, spatially correlated Rician fading.
[32]	Coverage and positioning are discussed in this paper.
[33]	This paper designs a Channel estimation scheme for large LIR-assisted multi-user wireless communication systems.
[34]	This study discusses the implementation problems associated with the interconnection data rate in the LIS. It additionally examined the system capacity and implementation cost with various design parameters and provided design suggestions for LIS installation.

2.3. Categorizing Recent Studies on Radio Stripes

The RS concept represents the implementation of a viable CF mMIMO network. It is made up of a stripe that is linked to a CPU, to which a huge number of antennas are connected and collaborate phase-coherently. The APs are stacked one on top of the other on the same cable. This lets them synchronize, transfer data, and get power over a single link, getting rid of the requirement for separate fronthaul links between each AP and its CPU [9,37].

Radio stripes can be used anywhere and at any time (Figure 3 [14]). For busy environments such as stadiums, stations, and shopping malls, a cell-free technique of deployment based on radio stripes was also suggested [38]. Many APs are connected by a single fronthaul cable, which also serves as a means of data transport, power transmission, and synchronization. A consecutive procedure, dubbed “normalized-MMSE” (N-MMSE) was published for the radio stripe cell-free technique, which creates nearby Aps. The striped system consists of numerous antenna PBs with maximum transmit energy restrictions that coherently beamform power signals towards devices that utilize CSI acquired through up-

link retraining and power transfer efficiency (PTE) data of the energy harvesting (EH) circuits at the user equipment's (UEs). Cutting-edge precoders are adopted that attempt to lower radio stripe transmit power and must meet tight EH specifications per UE [37].

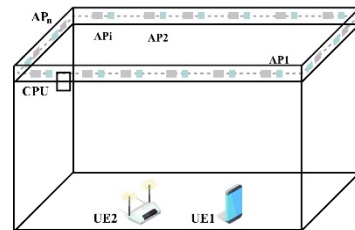

Figure 3. Block diagram of a typical scenario of radio stripe deployment [14].

2.3.1. Radio Stripes Are Inexpensive

The radio stripe system enables flexible and low-cost cell-free massive MIMO implementation. Radio stripes are inexpensive owing to its use in a variety of ways: deployment does not require the use of highly qualified personnel. In theory, an RS requires only one (plug and play) connection to the fronthaul network or directly to the CPU; a standard distributed mMIMO deployment necessitates a star topology, i.e., a unique cable between each AP and the CPU, which may be financially nonviable. The amount of antenna elements has less impact on the difficulty of installing an RS due to its compute-and-forward nature. As a result, cabling is significantly less expensive. Although the star topology may provide a better performance, the cost of installing the front-haul network may be too high. To arrange radio stripes, antenna elements are embedded into long front-haul cables. As a result, a star topology with many RS is formed, and coverage is enhanced. Note that the maintenance costs are reduced because an RS system is more reliable and resilient. This results in highly distributed functionality, meaning that a few broken stripes have less impact on the network as a whole. It is worth noting that the low heat dissipation makes cooling systems easier and less expensive [39].

2.3.2. Simple Implementation

While cellular APs are large, RS enable discreet placement in existing structural elements. Sensors for vibration, temperature, microphones, and speakers may also be included in an RS deployment, as well as for other functions such as fire alarms, burglar alarms, earthquake alerts, interior navigation, and climate monitoring and control.

The RS installation necessitates a small and compact antenna. The use of millimeter wave (mmWave) ($f_c > 30$ GHz) in radio stripe networks allows for very compact antenna elements, making the mmWave band ideal for the purpose of providing exceptionally fast data rates (1–5 Gb/s) and ubiquitous connection. RS can be used in virtually any place. RS can be placed inside metros, buses, and populated streets [14].

2.3.3. Radio-Stripe Network Propagation

In a cellular or cell-free wireless network, waves must travel hundreds of meters (from the base station/AP to the user and vice versa), which may experience little attenuation in the sub-6 GHz range but substantial attenuation in the mmWave spectrum over the equal space. However, as the radio stripe is distributed in every nook and cranny, the distance between the AP and users is only a few meters. As a result, propagation concerns such as air absorption, rain, and penetration through walls, become null or minimal [14].

2.3.4. Radio Stripe Network Path Loss

Even though most mm-Wave propagation concerns have been resolved in radio stripe networks, path loss remains the most significant propagation difficulty, particularly in very high bands ($f_c > 100$ GHz). The omnidirectional free space path loss increases with

frequency according to Friis law (the power received is equal to the square of the wavelength).

However, the authors demonstrated that path loss may be compensated for with a proportional increase in antenna gain and suitable beamforming. Thus, the mmWave propagation problem in radio stripe networks can be overcome [14].

2.3.5. Radio Stripe Network Energy Efficiency

In a cell-free massive MIMO system, with Random AP Switch Off (RAPSO), you can save power consumption and make the cell-free mMIMO technology that relies on radio stripes (CFMMSBRS) more energy efficient [39].

Table 3 lists the findings of recent studies on radio stripes.

Table 3. Representative Overview of Recent Studies on Radio Stripes.

Reference	Main Contribution
[9]	This research examines an uplink power allocation strategy aimed at improving network spectral efficiency (SE), which is described as an optimization-constrained issue explicitly considering the max-min fairness situation.
[14]	This paper present advantages of using radio stripes in mm waves.
[37]	This article demonstrates how inexpensive it is to implement and operate cell-free radio stripes.
[38]	This paper evaluates energy consumption of radio stripes with ideal CSI.
[39]	This approach suppresses interference in cell-free mMIMO while minimizing the cost and front-haul requirements.

The following Table 4 provides a summary of the characteristics of IRS, LIS, and radio stripes considering their properties and application.

Table 4. Comparison between IRS, LIS, and Radio Stripes.

	IRS	LIS	Radio Stripes
Structure	Massive-MIMO	Beyond Massive-MIMO	Cell-free Massive MIMO
Antenna type	Passive	Active	Active/Passive
Deployment	Easy	Easy	Easy
Capacity/data rate	High	High	High
Energy efficiency	Good	Slightly high	-
Channel estimate	Critical	Solved	-
Propagation	Near-field	Near-field	Near-field

3. System and Signal Characterization

mMIMO techniques in the mmWave frequency range can result in significant performance increases. However, massive antenna arrays allow the use of multiple antennas and spatial multiplexing techniques, providing an extra rise in data rates or improved dependability, with the potential of both advantages being realized concurrently by ensuring a connection among them. As a result, keeping receiver complexity low is critical, necessitating low-complexity frequency domain equalization (FDE) detectors, including the MRC and EGC, which do not necessitate inversion of the high-dimensional channel matrix for every frequency part, as needed for the ZF and MMSE receivers, while performing similarly. In order to avoid such matrix inversion, MRC and EGC can be used either as post-processing (at the receiver) or as pre-processing (precoding) components [33,40].

In massive MIMO systems, there are numerous methods to design the receiver, which can make things more or less complicated. In this type of system, methods based on matrix inversions, such as ZF and MMSE, are plainly detrimental. Even if their error probability performances are good, the complexity rises exponentially as the transmitting and receiving antenna count increases [41].

Accordingly, these receivers can be classified as:

- Linear feedforward, non-iterative FDE receivers (this type includes the ZF, MMSE, MRC, and EGC).
- Iterative MRC and EGC, FDE receivers, known as iterative block-decision feedback equalization (IB-DFE) receivers.

When used in conjunction with the necessary cyclic prefixes and FDE methods, block transmission methodologies have been shown to be suitable for high-data-rate transmission across extremely time-dispersive channels. The most widely used modulation based on this technology is orthogonal frequency division multiplexing (OFDM). An alternate approach based on this premise is single carrier (SC) modulation utilizing FDE (known as SC-FDE). The data blocks, as in OFDM, are preceded by a cyclic prefix that is large enough to account for the total channel length. SC-FDE techniques are especially appealing when simple and efficient power amplification is needed [12]. This is because the envelope variations of the broadcasted signals are smaller, resulting in a smaller peak-to-average power ratio.

In [25,42], the authors suggested a promising IB-DFE technique for SC-FDE that was later expanded to include additional diversity and spatial multiplexing [5] schemes. These IB-DFE receivers are iterative DFE receivers with frequency-domain feedforward and feedback operations that perform much better than non-iterative approaches do [42]. IB-DFE receivers can alternatively be conceived of as frequency-domain applications of turbo equalization (Figure 4).

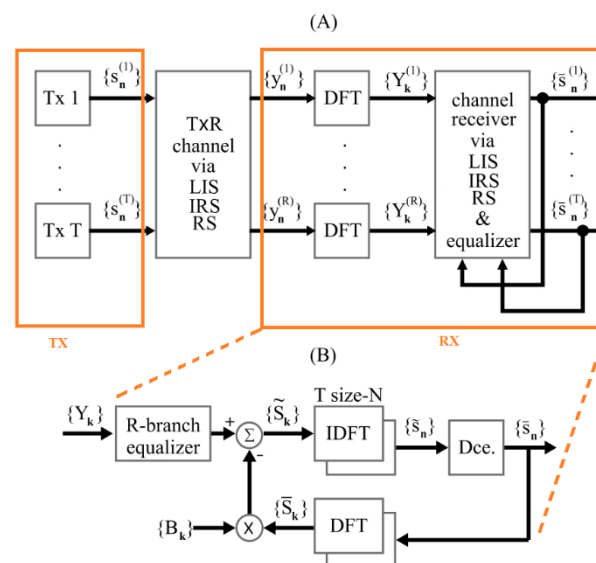

Figure 4. (A) block diagram of OFDM/SC-FDE iterative FDE receiver. (B) IB-DFE receiver structure.

As the MRC and EGC algorithms generate some interference in the receiver, we add an interference elimination method that follows the IB-DFE receiver design and allows these algorithms to perform very close to the matched filter boundary. In this situation, MRC and EGC receptors are iterative.

System Model and Receiver Design of Receivers

Figure 5 shows a reflector that assists communications. It looks at a communications system in which N reflecting components are added to a reflecting device to improve communication from a BS/AP with M antennas to K users with only one antenna.

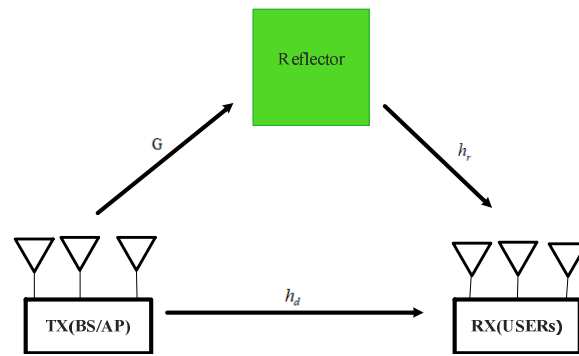

Figure 5. Block diagram of an IRS-assisted multi-antenna communication system.

Let $G \in \mathbb{C}^{M \times N}$, $h_r \in \mathbb{C}^{N \times 1}$ and $h_d \in \mathbb{C}^{M \times 1}$ denote the equivalent channels of the (AP/BS \leftrightarrow Reflector), (Reflector \leftrightarrow user) with k link.

Then, the received signal of the k th user can be expressed as

$$Y_k = \underbrace{h_d^H S_k}_{\text{Direct} \cdot \text{Link}} + \underbrace{h_r^H \theta^H G S_k}_{\text{Reflected} \cdot \text{Link}} + N_k \tag{1}$$

where θ indicates a matrix of $N \times N$ diagonal reflection coefficient, which can be written as $\theta = \text{diag}(\varphi_1, \varphi_2, \dots, \varphi_n)$, $\varphi_n = a_n \exp(j\phi_n)$, $a_n \in [0, 1]$, $\phi_n \in (0, 2\pi)$ and N_k denotes the additive white Gaussian noise (AWGN) at the receiver of k th user, with zero mean and variance σ_k^2 .

The k th user’s received signal-to-interference plus noise ratio (SINR) can be stated as

$$\text{SINR}_K = \frac{|h_d^H + h_r^H \theta^H G|^2}{|h_d^H + h_r^H \theta^H G|^2 + \sigma_k^2} \tag{2}$$

and the equivalent attainable rate, expressed in bits per second per Hz (bits/s/Hz),

$$R_k = \log_2(1 + \text{SINR}_k) \tag{3}$$

with

$$h_d^H + h_r^H \theta^H G = H_k \tag{4}$$

$$Y_k^{(l)} = S_k H_k^{(l)} + N_k^{(l)} \tag{5}$$

For evaluation of two different receivers, we need information about the feedforward and feedback matrices, where F_k denotes feedforward and B_k stands for the feedback matrices.

Using the ZF algorithm, F_k becomes [42]

$$F_k = (H_k^H H_k)^{-1} H_k^H \tag{6}$$

For a linear MMSE-based receiver

$$F_k = (H_k H_k^H + \beta I)^{-1} H_k^H \tag{7}$$

$$\beta = \frac{\sigma_N^2}{\sigma_S^2} = \frac{E[|N_k|^2]}{2} / \frac{E[|S_k|^2]}{2} \tag{8}$$

where I denotes an appropriate identity matrix and β denotes the assumed identical values for all values.

Using the MRC algorithm, F_k becomes

$$F_k = H_k^H \quad (9)$$

Using the EGC algorithm, F_k is given by

$$F_k = e^{j * \text{Arg}(H_k^H)} \quad (10)$$

In IB-DFE receivers, the ideal feedforward and feedback coefficients are provided by

$$F_k^{(l,i)} = \frac{H_k^{(l)*}}{\beta + (1 - (\rho^{(i-1)})^2) \sum_{l'=1}^L |H_k^{(l')}|^2} \quad (11)$$

$$B_k^{(i)} = \rho^{(i-1)} \left(\sum_{l'=1}^L F_k^{(l',i)} H_k^{(l')} - 1 \right) \quad (12)$$

with

$$\rho^{(i)} = \frac{E[s_n^* \hat{s}_n^{(i)}]}{E[|s_n|^2]} \quad (13)$$

4. Conclusions

In this article, it was stated that an IRS receives a signal from another location and scatters it in a controllable way. It acts like a (semi-)passive large array. It might be considered as an advantage considering the capacity/data rate and power optimization, although channel estimation is a concern. In contrast, it was described that the LIS was first utilized as a large active antenna array, being similar to a massive MIMO but much bigger and beyond mMIMO. A LIS generates, transmits, and receives signals. The arrays are not only of high dimensions, but they are also made up of very small parts. These characteristics allow them to control electromagnetic waves over the surface almost continuously. In addition to the existing advantages of the IRS, the channel estimation issue has improved. In contrast, RS are a practical implementation of cell-free mMIMO, in which a network's user equipment shares the same time-frequency resources as a collection of multi-antenna APs.

5. Future Research

According to Section 3 and the explanation of the system model, low-complexity receivers as a challenge are a future research topic. Future research should utilize the highly efficient LDPC codes and block transmission techniques.

Funding: This work is funded by FCT/MCTES through national funds and when applicable co-funded EU funds under the projects UIDB/EEA/50008/2020 and 2022.03897.PTDC.

Institutional Review Board Statement: Not applicable.

Informed Consent Statement: Not applicable.

Data Availability Statement: Not applicable.

Acknowledgments: We acknowledge the support of FCT/MCTES, as described above in funding. We also acknowledge the support of Autonoma TechLab for providing an interesting environment to carry out this research.

Conflicts of Interest: The authors declare no conflict of interest.

References

1. Dajer, M.; Ma, Z.; Piazzzi, L.; Prasad, N.; Qi, X.-F.; Sheen, B.; Yang, J.; Yue, G. Reconfigurable intelligent surface: Design the channel—A new opportunity for future wireless networks. *Digit. Commun. Netw.* **2021**, *8*, 87–104. [[CrossRef](#)]
2. Gong, S.; Lu, X.; Hoang, D.T.; Niyato, D.; Shu, L.; Kim, D.I.; Liang, Y.C. Toward Smart Wireless Communications via Intelligent Reflecting Surfaces: A Contemporary Survey. *IEEE Commun. Surv. Tutor.* **2020**, *22*, 2283–2314. [[CrossRef](#)]
3. Zhao, J.; Liu, Y. Survey of Intelligent Reflecting Surfaces (IRSs): Towards 6G Wireless Communication Networks. *arXiv* **2019**, arXiv:1907.04789v3.
4. Marques da Silva, M.; Guerreiro, J. On the 5G and beyond. *Appl. Sci.* **2020**, *10*, 7091. [[CrossRef](#)]
5. Al-Jarrah, M.; Alsusa, E.; Al-Dweik, A.; So, D.K.C. Capacity Analysis of IRS-Based UAV Communications with Imperfect Phase Compensation. *IEEE Wirel. Commun. Lett.* **2021**, *10*, 1479–1483. [[CrossRef](#)]
6. Pereira, A.; Rusek, F.; Gomes, M.; Dinis, R. Deployment Strategies for Large Intelligent Surfaces. *IEEE Access* **2022**, *10*, 61753–61768. [[CrossRef](#)]
7. Pereira, A.; Rusek, F.; Gomes, M.; Dinis, R. On the Complexity Requirements of a Panel-Based Large Intelligent Surface. In Proceedings of the IEEE Global Communications Conference 2020, Taipei, Taiwan, 7–11 December 2020.
8. Hu, S.; Rusek, F.; Edfors, O. The Potential of Using Large Antenna Arrays on Intelligent Surfaces. *arXiv* **2017**, arXiv:1702.03128v1.
9. Conceicao, F.; Antunes, C.H.; Gomes, M.; Silva, V.; Dinis, R. User Fairness in Radio Stripes Networks using Meta-Heuristics Optimization. In Proceedings of the 2022 IEEE 95th Vehicular Technology Conference: (VTC2022-Spring), Helsinki, Finland, 19–22 June 2022.
10. Van Chien, T. *Spatial Resource Allocation in Massive MIMO Communications: From Cellular to Cell-Free*; Linköping University Electronic Press: Linköping, Sweden, 2020.
11. Marques da Silva, M.; Dinis, R. Power-Ordered NOMA with Massive MIMO for 5G Systems. *Appl. Sci.* **2021**, *11*, 3541. [[CrossRef](#)]
12. Wang, Z.; Liu, L.; Zhang, S.; Cui, S. Massive MIMO Communication with Intelligent Reflecting Surface. *arXiv* **2022**, arXiv:2107.04255v2. [[CrossRef](#)]
13. Lu, L.; Li, G.Y.; Swindlehurst, A.L.; Ashikhmin, A.; Zhang, R. An Overview of Massive MIMO: Benefits and Challenges. *IEEE J. Sel. Top. Signal Process.* **2014**, *8*, 742–758. [[CrossRef](#)]
14. Mishra, A.K.; Ponnusamy, V. Millimeter Wave and Radio Stripe: A Prospective Wireless Technology for 6G and Beyond Networks. In Proceedings of the 2021 Smart Technologies, Communication and Robotics (STCR), Sathyamangalam, India, 9–10 October 2021.
15. Wu, Q.; Zhang, Y.; Huang, C.; Chau, Y.; Yang, Z.; Shikh-Bahaei, M. Energy Efficient Intelligent Reflecting Surface Assisted Terahertz Communications. In Proceedings of the 2021 IEEE International Conference on Communications Workshops, ICC Workshops, Montreal, QC, Canada, 14–23 June 2021.
16. Hu, S.; Chitti, K.; Rusek, F.; Edfors, O. User Assignment with Distributed Large Intelligent Surface (LIS) Systems. In Proceedings of the 2018 IEEE 29th Annual International Symposium on Personal, Indoor, and Mobile Radio Communications (PIMRC), Bologna, Italy, 9–12 September 2018.
17. Shah, A.S. A Survey from 1G to 5G Including the Advent of 6G: Architectures, Multiple Access Techniques, and Emerging Technologies. In Proceedings of the IEEE 12th Annual Computing and Communication Workshop and Conference (CCWC), Las Vegas, NV, USA, 26–29 January 2022; pp. 1117–1123.
18. Zheng, Y.; Wang, C.X.; Yang, R.; Yu, L.; Lai, F.; Huang, J.; Feng, R.; Wang, C.; Li, C.; Zhong, Z.; et al. Ultra-Massive MIMO Channel Measurements at 5.3 GHz and a General 6G Channel Model. In *IEEE Transactions on Vehicular Technology*; Institute of Electrical and Electronics Engineers Inc.: Piscataway, NJ, USA, 2022. [[CrossRef](#)]
19. Elbir, A.M.; Coleri, S.; Mishra, K.V. Federated Channel Learning for Intelligent Reflecting Surfaces with Fewer Pilot Signals. In Proceedings of the 2022 IEEE 12th Sensor Array and Multichannel Signal Processing Workshop (SAM), Trondheim, Norway, 20–23 June 2022.
20. Yan, W.; Yuan, X.; Kuai, X. Passive Beamforming and Information Transfer via Large Intelligent Surface. *IEEE Wirel. Commun. Lett.* **2019**, *9*, 533–537. [[CrossRef](#)]
21. Zhang, S.; Zhang, R. Capacity Characterization for Intelligent Reflecting Surface Aided MIMO Communication. *IEEE J. Sel. Areas Commun.* **2020**, *38*, 1823–1838. [[CrossRef](#)]
22. Mu, X.; Liu, Y.; Guo, L.; Lin, J.; Al-Dhahir, N. Capacity and Optimal Resource Allocation for IRS-Assisted Multi-User Communication Systems. *IEEE Trans. Commun.* **2021**, *69*, 3771–3786. [[CrossRef](#)]
23. Yang, Z.; Chen, M.; Saad, W.; Xu, W.; Shikh-Bahaei, M.; Poor, H.V.; Cui, S. Energy-Efficient Wireless Communications with Distributed Reconfigurable Intelligent Surfaces. *IEEE Trans. Wirel. Commun.* **2022**, *21*, 665–679. [[CrossRef](#)]
24. Cho, H.; Choi, J. IRS-Aided Energy Efficient UAV Communication. *arXiv* **2021**, arXiv:2108.02406.
25. Pan, Y.; Deng, Z. Channel Estimation for Wireless Communication Systems Aided by Large Intelligent Reflecting Surface. In Proceedings of the 2021 IEEE 2nd International Conference on Big Data, Artificial Intelligence and Internet of Things Engineering (ICBAIE), Nanchang, China, 26–28 March 2021.
26. Marques da Silva, M.; Dinis, R.; Martins, G. On the Performance of LDPC-Coded Massive MIMO Schemes with Power-Ordered NOMA Techniques. *Appl. Sci.* **2021**, *11*, 8684. [[CrossRef](#)]

27. Hu, S.; Rusek, F.; Edfors, O. Capacity Degradation with Modeling Hardware Impairment in Large Intelligent Surface. In Proceedings of the 2018 IEEE Global Communications Conference (GLOBECOM), Abu Dhabi, United Arab Emirates, 9–13 December 2018.
28. Sanchez, J.R.; Rusek, F.; Edfors, O.; Liu, L. An Iterative Interference Cancellation Algorithm for Large Intelligent Surfaces. *arXiv* **2019**, arXiv:1911.10804v1.
29. Pereira, A.; Rusek, F.; Gomes, M.; Dinis, R. A Low Complexity Sequential Resource Allocation for Panel-Based LIS Surfaces. In Proceedings of the 2022 IEEE 95th Vehicular Technology Conference: (VTC2022-Spring), Helsinki, Finland, 19–22 June 2022.
30. Alegría, J.V.; Rusek, F.; Sánchez, J.R.; Edfors, O. Modular Binary Tree Architecture for Distributed Large Intelligent Surface. In Proceedings of the IEEE—ICASSP 2021, Toronto, ON, Canada, 6–11 June 2021.
31. Jung, M.; Saad, W.; Jang, Y.; Kong, G.; Choi, S. Performance Analysis of Large Intelligent Surfaces (LISs): Asymptotic Data Rate and Channel Hardening Effects. *arXiv* **2019**, arXiv:1810.05667v4. [[CrossRef](#)]
32. Sanchez, J.R.; Rusek, F.; Edfors, O.; Liu, L. Distributed and Scalable Uplink Processing for LIS: Algorithm, Architecture, and Design Trade-offs. *arXiv* **2020**, arXiv:2012.05296v1.
33. Hu, S.; Rusek, F.; Edfors, O. Beyond Massive MIMO: The Potential of Data Transmission with Large Intelligent Surfaces. *IEEE Trans. Signal Process.* **2018**, *66*, 2746–2758. [[CrossRef](#)]
34. Kundu, N.K.; McKay, M.R. Channel Estimation for Large Intelligent Surface Aided MISO Communications: From LMMSE to Deep Learning Solutions. *arXiv* **2020**, arXiv:2011.07265v1.
35. Sanchez, J.R.; Edfors, O.; Rusek, F.; Liu, L. Processing Distribution and Architecture Tradeoff for Large Intelligent Surface Implementation. In Proceedings of the 2020 IEEE International Conference on Communications Workshops (ICC Workshops), Dublin, Ireland, 7–11 June 2020.
36. Dardari, D. Communicating with Large Intelligent Surfaces: Fundamental Limits and Models. *arXiv* **2020**, arXiv:1912.01719v2. [[CrossRef](#)]
37. Ma, Y.; Yuan, Z.; Yu, G.; Chen, Y. Cooperative Scheme for Cell-Free Massive MIMO with Radio Stripes. In Proceedings of the 2021 IEEE International Conference on Communications Workshops (ICC Workshops), Montreal, QC, Canada, 14–23 June 2021.
38. López, O.L.; Kumar, D.; Souza, R.D.; Popovski, P.; Tölli, A.; Latva-Aho, M. Massive MIMO With Radio Stripes for Indoor Wireless Energy Transfer. *IEEE Trans. Wirel. Commun.* **2022**, *21*, 7088–7104. [[CrossRef](#)]
39. Shaik, Z.H.; Björnson, E.; Larsson, E.G. Cell-Free Massive MIMO with Radio Stripes and Sequential Uplink Processing. *arXiv* **2020**, arXiv:2003.02940v1.
40. Pereira, A.; Bento, P.; Gomes, M.; Dinis, R.; Silva, V. Complexity analysis of FDE receivers for massive MIMO lock transmission systems. *IET Commun.* **2019**, *13*, 1762–1768. [[CrossRef](#)]
41. Da Silva, M.M.; Dinis, R. A simplified massive MIMO implemented with pre or postprocessing. *Phys. Commun.* **2017**, *25*, 355–362. [[CrossRef](#)]
42. Borges, D.; Montezuma, P.; Dinis, R. Low Complexity MRC and EGC Based Receives for SC-FDE Modulations with Massive MIMO Schemes. In Proceedings of the IEEE Global Conference on Signal and Information Processing (GlobalSIP), Washington, DC, USA, 7–9 December 2016.